



INSTYTUT
AKTYWIZACJI
I ROZWOJU
SPOŁECZNEGO



Co-funded by
the European Union

MANUAL OF EDUCATIONAL PROGRAMS FOR YOUTH GROUPS





ERASMUS+ IN GAME



Co-funded by
the European Union

Project number : 2021-2-PL01-KA153-YOU-000040262

Disclaimer: This project has been funded with support from the European Commission. This publication [communication] reflects the views only of the author, and the Commission cannot be held responsible for any use which may be made of the information contained therein.

COORDINATOR - Patryk Stolarczyk

TOOLKIT DESIGN & ILLUSTRATION - Burcea Alexandra Diana



TABLE OF CONTENTS

COORDINATOR



- 001. Table of contents
- 002. Welcome to the INGAME Toolkit!
- 003. Introduction

- 004. Days of our Project
- 011. Audio Puzzles
 - 012. Audio Puzzles - intro
 - 013. Audio Storyline
 - 014. Audio Code
- 015. Water Puzzles
 - 016. Water Tube Puzzles
 - 017. Water + fire puzzle
 - 018. Water gun puzzles
- 019. Labyrinths and Mazes
 - 020. Explanation
 - 021. Labyrinths in use
 - 022. Mazes in use
- 025. Ciphers
 - 026. Chocolate Cipher
 - 027. Caesar Cipher
 - 028. Vigenere Cipher
 - 029. Graphic code Cipher
- 030. Mechanical Puzzles
 - 031. Example 1
 - 037. Example 2
- 041. Random Puzzle Ideas
 - 042. Bottle Puzzle
 - 043. Frame Puzzle
 - 044. Building Puzzle
 - 045. Stamp Puzzle
 - 046. Transparent Paper Puzzle
 - 047. Sensory Box Puzzle
 - 048. Tinting Foil + Counting objects puzzle
- 049. Scenarios
 - 050. Mood Killer
 - 052. The Magic Picnic
 - 055. Circus: Behind the Scenes
 - 058. Seven Wonders Robbery



WELCOME TO THE IN GAME TOOLKIT!

The place created by our participants just for you! :)

Looking for ideas for your educational escape room?
Wanna make some boring classes more interesting?
We got you covered!

What can you find in our toolkit?

-Introduction to our project: If you want to get inspired for your own Erasmus + project, this is the right place to start

- Task and puzzles: Over 50 tasks and ideas that you can use in your own game!

-Tips for the games: Useful solutions and ideas on how to make your escape room or any other game more fun

Scenarios: Four free to play scenarios created by our participants



INTRODUCTION

In this tool kit you will get to know more about the:

-IN GAME Erasmus KA1 PROJECT-

- >You are going to be introduced to the activities that we have done each day , the strategies we followed to create our own escape rooms from the first steps that we used.
- >Additionally the workshop activities that were implemented to achieve the objectives of this project.
- >The aim of this project was not only focusing on creating escape rooms, but also exchanging cultures in different activities.

The IN GAME project objectives

- Converting stories into games
- Using Escape rooms in educational settings
- Different types of Escape rooms
- Exchange cultures with different countries
- Creating Escape rooms from scratch with the help of experts in the field
- Soft skills like presentation skills, teamwork and leadership.
- Learning how to create and solve puzzles.



DAYS
OF OUR PROJECT
HELD IN LUBLIN

May 14, Saturday

DAY 0

>The first day was the start of our fantastic journey on the Erasmus project **INGAME** held in **Lublin, Poland**.

>During the project, we had the opportunity to learn in depth about escape rooms, specifically about **how to create educational ones**.

>People from five different countries were included in the project. This is why **communication** and **team bonding** was the theme of our first day. We achieved this through several topic related games.

>The games were created with the purpose to trust each other and working in a team so we can cooperate better during the following days.



May 15, Sunday

DAY 1

>The first day of us getting to know more about **escape rooms** included a **city game**.

>While we were exploring the city we also learned more about different **puzzles** and the importance of **storytelling**, which was what our workshop based on. To practice it, we were introduced to a game with the point to create a story based on cards given to us. This helped improve our **creativity and storytelling skills**.



May 16, Monday
DAY 2

WORKSHOP

- >In day 2, we started to learn about the industry of escape rooms in order to learn how to design and implement an efficient escape room.
- >During the training we got useful information about Escape room requirements, the rules that each escape room creator need make known to their players, safety conditions, and the terms and conditions.
- >The importance of choosing the name is as important as setting the game rules, as the name of the game is the first thing that catches the players attention.
- >In addition, when creating an ER*, you need to focus on the purpose of the room, and in our case we were focusing on Educational settings, for example, practicing a foreign language, soft skills and groupwork.
- >Lastly, Getting more knowledgeable about ERs and the mechanisms of creating them, we got to better develop our simple ideas into practical ready to be implemented ideas.

International night

The Spanish and the Greek team took over this night with introducing beautiful music, dances, traditions and food.



May 17, Tuesday

DAY 3

WORKSHOP

>On Day 3, we learned about different Escape room types, which are: classic, virtual, urban, box and board game.

>On this day, we learnt in a more practical approach. In order to put our ideas into reality, we explored how to use **Genially*** to create a virtual room.

>In **Genially**, you can add buttons, create smooth movements between scenes, animation for the text show, secret messages, adding password to a page and use invisible pages to hide clues.

>Moreover, for this practical training to be completed, we got to visit the local escape rooms ourselves. We got to play and discover creative ideas to brainstorm puzzles for our project and develop our own Escape Rooms.

>Hence, our ER ideas were getting more concrete, as we got inspired by various ideas we saw in the Lublin ER, and the hands-on experience in the virtual ER.

International night

>The Polish, Bulgarian and Romanian teams took over this night by introducing facts about their countries, cultural differences and traditional dances.



IN GAME 008

*Genially = online platform for interactive animated content

May 18, Wednesday

DAY 4

>In day four, after we had visited the escape room, we had a wider understanding of how they work and how our puzzles should look like.

>We got introduced by the trainer to different kinds of puzzles we didn't know about, and he also explained how some of them work.

>During the workshop we had the opportunity to create puzzles which could be done by anyone with little to no resources.

>After this, we implemented some of these puzzles into our own escape rooms.



May 19, Thursday

DAY 5

>On this day, we got to collect all the ideas and the learning outcomes we got from the previous days since day one, by dividing ourselves into groups.

>Each group contributed in some form or another to the creation of this toolkit. This way, we extended the benefits of this project outside the limited duration of the project, which was only one week.

>This summary of this project will be shared through the toolkit guide as well as social media posts. :)





PUZZLES

AUDIO PUZZLES

AUDIO PUZZLES

>Many games use sounds as puzzles, as there are many varieties and it's always fun for your players to use their **sense of hearing**. Here you can find some puzzles that use sound as a tool!

>You can use many methods of playing the audio depending on what fits your room the best.

>For example, in a detective escape room, you can use **audio tapes**, **recorders** or **DVDs**. You can also start playing manually after you see your players solve some kind of puzzle!



AUDIO STORYLINE

>Upon playing the audio, players hear the story told by a person. It can be a part of the diary that the person was recording or a fraction of the interrogation of a prisoner. Whatever fits your game.

>The players have to put the information in the right order. For example the narrator of the tape is telling the road that he had to travel.

>Participants have access to many pictures of roads and places, and using the information received from the tape, they have to pick the correct images in the right order to advance further in the game.

Transition to other puzzles

Each picture can have a number on the back, and after picking the right ones, players will gain access to a code.

Variants

- You can use the **Genially** platform to make interactive point and click games, in which the players will have to click on the right area to advance further
- You can change the **level of difficulty** by changing the description of the places, for example the easy version can provide things that stand out on the photos. The hard one can have only small details that are harder to spot.
- You can change freely what the voice is describing and saying, use this example as an inspiration :)
- Players can find pieces of the story throughout of the game.

AUDIO CODE

>Upon playing an audio, players can hear a sequence of words, noises or letters.

The sequence is a code that they will have to use in order to solve a puzzle.

>For example, there are pictures of animals taped on the walls, and each picture has a corresponding number.

Lion - 5
Elephant - 6
Dog - 2
Eagle - 8

>At first, when they enter the room, the task is not obvious, but after they gain access to the audio they can hear the sounds of the animals in the order:

Elephant-Dog-Lion-Eagle

So the right code is:

6-2-5-8

Transition to other puzzles

When they get the code, they can use it in different ways: locks, password in electronic. It's up to your imagination!

Variants

- You can put more animals on the walls so they have to search for the right ones
- You can make text slower and put it in the reverse
- You can play two sounds at once so they have to concentrate on the right audio

!make sure that the message is not so long, as it might be exhausting!



PUZZLES

WATER PUZZLES

WATER PUZZLES

Water Tube puzzle

- >The idea is pretty simple, in the game area there is a tube with a key on the bottom.
- >The tube is attached and can't be moved by players (make sure that players will not use force!) Also it's too tight to slip a hand inside.
- >On the bottom of the tube there is an object: key or a code, players will have to fill the tube with water so it pushes the object out.

Water Tubes puzzle

- >This puzzle uses tubes as well, in the room the player finds tubes that are next to each other with the numbers written in between. (The tubes have to be marked, you can do it by the alphabet, numbers or signs)

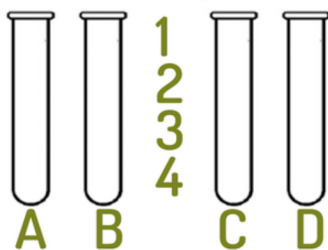

- >Players also have access to cups in different sizes, and paper that shows what cup they should use on the witch tube. Their task is to fill the tubes to a certain level of water that will indicate the right number. So for example:



- >This means that the players have to pour three cups of water to tube A, two big cups and one small.
- >Level of water indicates the number, so in the example water in tube A shows 2

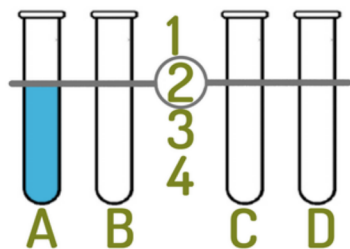

>**VARIANTS:** If you don't want to use water, you can use sand instead.

>**Notification:** Make sure the task is easily resettable, as the players might make a mistake during the game!

WATER PUZZLES

Water (and fire!) puzzle

>Players receive a blank paper, they have to put it under the water in order to read the message. How to make a hidden message?

>You will need a two regular blank papers

1. Put one blank paper into the water, then take it out
2. Put second blank paper onto to wet one and write the hidden message
3. Take out the second blank paper
4. Wait for the wet paper to dry out

>When the paper becomes dry there should be no sign of the message, it will be readable if the players put the paper into water again.

>Explanation: writing on the paper that is above the wet one causes micro damages, which are visible under the water.

>**Variant:** If you want to make a fire message, you can use a variants of methods, the simplest ones are:

Milk
Sweet white wine
Water and sugar
Lemon juice

>The only thing you need is to write a word using any of these fluids (we recommend lemon juice), after the players put the paper above the source of fire the message will appear.

>**This puzzle requires interaction with the fire element, so MAKE SURE that it is safe for the players.**

WATER PUZZLES

Water pistol puzzle

>An fun interactive thing to add to your escape room, here are some ideas that you can use!

Water Gun + a message hidden under dirt

>Put a message in the place which is not reachable for the players, put the dirt or any other thing that can be removed by a water source. Players have to shoot the water to clear the message and read it from the distance

Water Gun + Water message

>Put the hidden message papers (look at water message puzzle) in the place which is not reachable for the players. They will have to shoot the water onto the paper to read the hidden message

Water Gun + Balloon

>Put the key/message in the water balloon, the water balloon has to be attached to some kind of tube/hose and be out of the reach of the players, their task is to shoot the water into the hose/tube to make the balloon fall.

WATER PUZZLES

Water distribution puzzle

>On the table there are 3 cups A, B and C. There are also 8 smaller cups with water.

>Big cup B has already some water inside. Players have to distribute the water equally to each cup. The rules are:

Players can pour the water from the smaller cups only to Cup A

Players can pour water from Cup A only to Cup B

Players can pour water from Cup B only to Cup C

Players can make only 8 moves

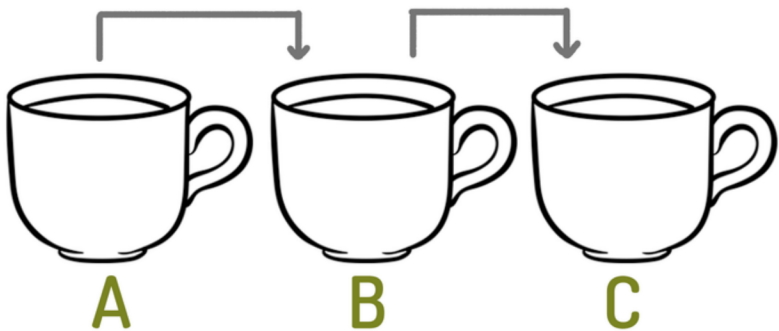

Moves:

A → B → C

A → A → B

A → A

>Variants: You can switch the number of moves and cups to make the task easier or harder

>Transition to other puzzles: After they pour the water equality, you can manually pass them the tip or the code, through door frame or window



PUZZLES

LABYRINTHS AND MAZES

LABYRINTHS AND MAZES

>In the creation process of your new game you can use both:

>**LABYRINTHS**, which have a single continuous path that leads to the center. Only thing you need to do to solve them is to keep going forward.

For example, 7 circuit labyrinths:

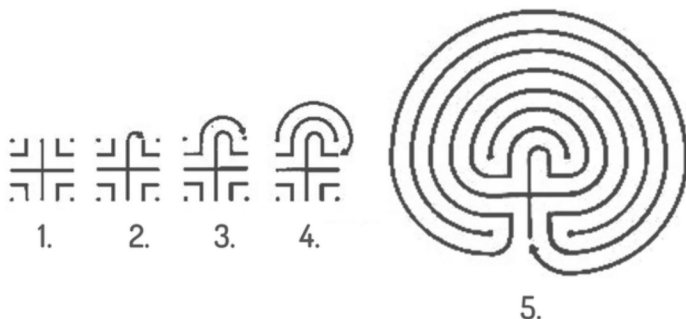

>**MAZES**, which have multiple paths that branch off and will not necessarily lead to the centre.

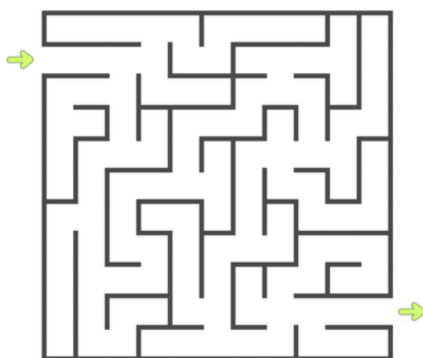

>**Help tools:**

Site where you can create any maze pattern. (solution can be included after downloading) :

<https://www.mazegenerator.net/>

Labyrinths in use

LABYRINTHS AND MAZES

>Labyrinths in use - puzzle examples:

You can use labyrinth as a plan for your game. Solving following puzzles will eventually get you to the center/reward.

They can be easy to arrange for younger ones, but keep in mind that a labyrinth isn't a difficult form of a puzzle.

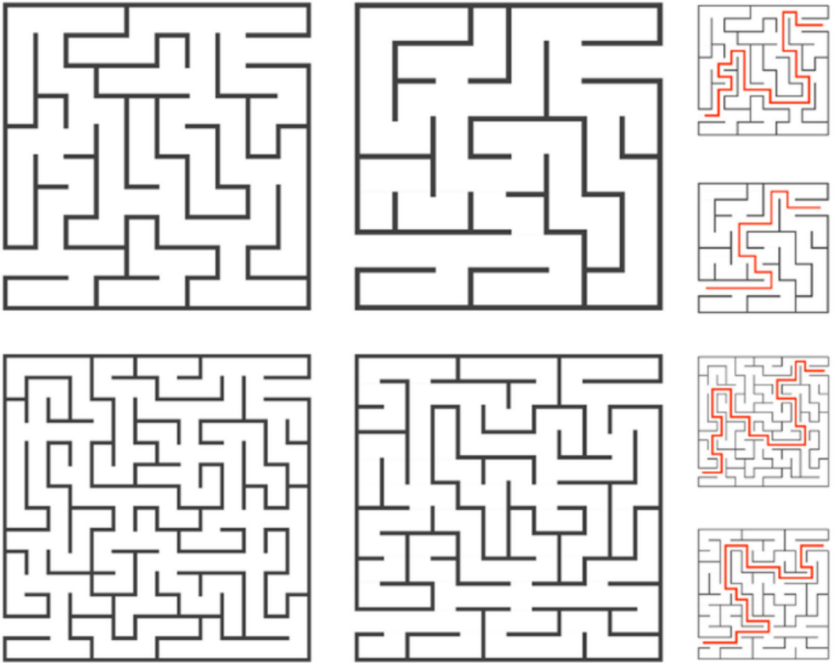

LABYRINTHS AND MAZES

>Maze in use - puzzle examples:

Type A: Magnetic maze

>**Goal of the maze:** to get a certain magnetic object out of the maze (ex. key) using only a magnet.

>**Puzzle example**

Participants: min. 2

Resources: cardboard/wood, multi surface glue, plexiglass, magnetic object, magnet.

Type: compact maze

>**Preparations:** Create a maze using resources from the list. Cardboard/wood would act as walls and base of the maze, plexiglass is gonna act as see-through barrier between contestant and object in the maze.

>On the back of the maze (visible to **P2***) write letters. Only by following the instructions of **P1** can they solve the maze and get the password from the back.

>**Course of the game:** There are 2 participants **P1** and **P2**. **P1** can see the maze but has no magnet to solve it. **P2** is standing on the other side, can not see the maze but has magnet to solve it. **P1** job is to guide **P2** through the maze. Only working together they can get the object out of the maze.

>**TIP:** There should be a master of the game, that'll make sure participants won't cheat and pass the magnet to **P1**. To avoid cheating you can also add one step to the game.

LABYRINTHS AND MAZES

Type B: Mechanic maze

>**Goal of the maze:** to get a certain object (ex.: ball out of the maze) using: gravity/mechanical force/some type of mechanism.

>**Puzzle example**

Participants: 1+

Resources: cardboard/wood, multi surface glue,

Type: compact maze

>**Preparations:** Create a maze using resources from the list. Cardboard/wood would act as walls and base of the maze; plexiglass is gonna act as see-through barrier between the contestant and object in the maze.

>**Course of the game:** To get the object out of the maze, the contestants have to manipulate it. The bigger the maze is, the more people will be needed to solve this puzzle.

>**Tip:** The object that is placed inside the maze should be round or easily movable like a ball.

LABYRINTHS AND MAZES

Type C: Regular maze

>**Goal of the maze:** finding the right path and get to the other end.

>**Puzzle example:**

Participants: 1+

Resources: cardboard boxes, tape

Type: large-area maze

>**Preparations:** Create maze using resources from the list. Create the path with boxes and secure them in place with the tape.

>**Course of the game:** Participants need to find a way through the maze.

>**Tip:** To make it more difficult or time consuming you can add any other type of maze or puzzle inside of the main one. To get further, participants will be forced to solve the smaller puzzles first.



PUZZLES

CIPHERS

CIPHER PUZZLES

>You can find codes in many games, they are easy to use and can fit in any theme.

>If you want to search for some more unique codes I would recommend Scouts books.

Here are our four ideas for you:

CHOCOLATE CIPHER

The chocolate is entirely based on replacing the letters with a graphic symbol.

In the cubes of "3 × 3 chocolate" we enter two letters of the alphabet one by one, so in the first box we will have AB, in the next CD, and in the last one RS. We also make an X with missing letters, lastly we make O with the last letter of the alphabet.

A	B	C	D	E	F
G	H	I	J	K	L
M	N	O	P	R	S

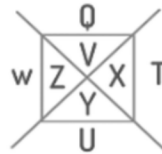

To write a specific letter, we sketch the grid in which it is located, and then mark its position in the given box with a dot.

For example



CIPHER PUZZLES

>Caesar cipher is one of the easiest to do and oldest ciphers.

>Basic idea is that the alphabet shifts by a number of your choice. So for example if it's the shift of 1, A would be replaced by B, in the shift of 3, A would be replaced by D.

I love Erasmus! - L oryh Hudvpxv!
(shift.3)

I love Erasmus! - K nqyg Gtcuowu!
(shift.2)

I love Erasmus! - P svcl Lyhztbz!
(shift.7)

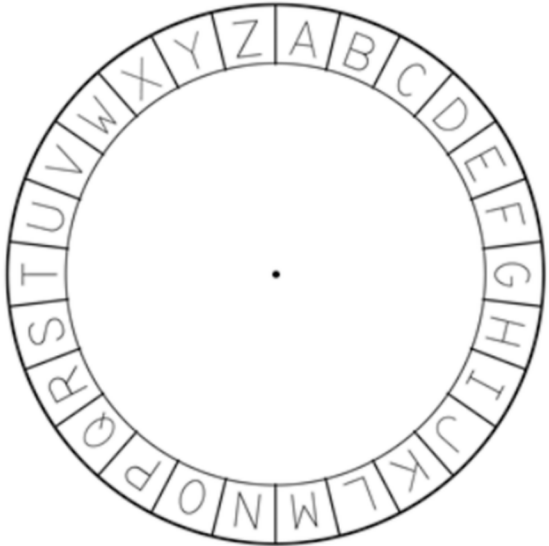

>If you want to complicate the lives of your players even more, you can hide to circle with right shift number so they have to find it first.

CIPHER PUZZLES

>Vigenère is one of the classic cipher algorithms. It's based on one specific table:

	A	B	C	D	E	F	G	H	I	J	K	L	M	N	O	P	Q	R	S	T	U	V	W	X	Y	Z
A	A	B	C	D	E	F	G	H	I	J	K	L	M	N	O	P	Q	R	S	T	U	V	W	X	Y	Z
B	B	C	D	E	F	G	H	I	J	K	L	M	N	O	P	Q	R	S	T	U	V	W	X	Y	Z	A
C	C	D	E	F	G	H	I	J	K	L	M	N	O	P	Q	R	S	T	U	V	W	X	Y	Z	A	B
D	D	E	F	G	H	I	J	K	L	M	N	O	P	Q	R	S	T	U	V	W	X	Y	Z	A	B	C
E	E	F	G	H	I	J	K	L	M	N	O	P	Q	R	S	T	U	V	W	X	Y	Z	A	B	C	D
F	F	G	H	I	J	K	L	M	N	O	P	Q	R	S	T	U	V	W	X	Y	Z	A	B	C	D	E
G	G	H	I	J	K	L	M	N	O	P	Q	R	S	T	U	V	W	X	Y	Z	A	B	C	D	E	F
H	H	I	J	K	L	M	N	O	P	Q	R	S	T	U	V	W	X	Y	Z	A	B	C	D	E	F	G
I	I	J	K	L	M	N	O	P	Q	R	S	T	U	V	W	X	Y	Z	A	B	C	D	E	F	G	H
J	J	K	L	M	N	O	P	Q	R	S	T	U	V	W	X	Y	Z	A	B	C	D	E	F	G	H	I
K	K	L	M	N	O	P	Q	R	S	T	U	V	W	X	Y	Z	A	B	C	D	E	F	G	H	I	J
L	L	M	N	O	P	Q	R	S	T	U	V	W	X	Y	Z	A	B	C	D	E	F	G	H	I	J	K
M	M	N	O	P	Q	R	S	T	U	V	W	X	Y	Z	A	B	C	D	E	F	G	H	I	J	K	L
N	N	O	P	Q	R	S	T	U	V	W	X	Y	Z	A	B	C	D	E	F	G	H	I	J	K	L	M
O	O	P	Q	R	S	T	U	V	W	X	Y	Z	A	B	C	D	E	F	G	H	I	J	K	L	M	N
P	P	Q	R	S	T	U	V	W	X	Y	Z	A	B	C	D	E	F	G	H	I	J	K	L	M	N	O
Q	Q	R	S	T	U	V	W	X	Y	Z	A	B	C	D	E	F	G	H	I	J	K	L	M	N	O	P
R	R	S	T	U	V	W	X	Y	Z	A	B	C	D	E	F	G	H	I	J	K	L	M	N	O	P	Q
S	S	T	U	V	W	X	Y	Z	A	B	C	D	E	F	G	H	I	J	K	L	M	N	O	P	Q	R
T	T	U	V	W	X	Y	Z	A	B	C	D	E	F	G	H	I	J	K	L	M	N	O	P	Q	R	S
U	U	V	W	X	Y	Z	A	B	C	D	E	F	G	H	I	J	K	L	M	N	O	P	Q	R	S	T
V	V	W	X	Y	Z	A	B	C	D	E	F	G	H	I	J	K	L	M	N	O	P	Q	R	S	T	U
W	W	X	Y	Z	A	B	C	D	E	F	G	H	I	J	K	L	M	N	O	P	Q	R	S	T	U	V
X	X	Y	Z	A	B	C	D	E	F	G	H	I	J	K	L	M	N	O	P	Q	R	S	T	U	V	W
Y	Y	Z	A	B	C	D	E	F	G	H	I	J	K	L	M	N	O	P	Q	R	S	T	U	V	W	X
Z	Z	A	B	C	D	E	F	G	H	I	J	K	L	M	N	O	P	Q	R	S	T	U	V	W	X	Y

>We can tell from it that each of the lines match the cipher that is moving. What means the movement in the first line is 0, in the second one is in third is 2 etc.

If we want to cipher something we have to have some keyword. The key word is secret and it tells us which line and column we should use at a specific moment.

Example:

If we want to cipher the sentence "I LOVE ERASMUS" and as a keyword we will take "PROJECT" we have to assign each letter from the keyword to the letters of our sentence. We are doing it in this specific way:

I LOVE ERASMUS
P ROJE CTP ROJE

>Now, using the table we cipher other signs.

>The letter of the keyword is standing for the line and the letter from our sentence is standing for the column. In the intersections of lines and columns we can find letters we have to resign as a letter of ciphered code.

>Our first sign from key word is "P" Next we're taking the letter from plaintext - "I"

>We have to search for the intersection of these letters in the table and resign it to the plain paper. It's gonna be the first sign of our ciphered text. In this case "X"

>Following pair of letters is "R" and "L". The sign which is standing for this is "C" After some time we're left with the whole coded sentence.

X CCEI GKPJADW
P ROJE CTPROJ E

In the same exact way we can easily decode the cipher.

CIPHER PUZZLES

>Every graphic represents a different number, in order to solve the cipher players have to identify the right graphic and write down the numbers.

>This kind of code is especially fun to use as it has many variants, can be mixed with other puzzles and can be reusable through the whole game.

>For example you can put many different graphics on the walls, players have to search for the right ones in order to get access to the right code.

>Example of symbols that you can use





PUZZLES

MECHANICAL PUZZLES

MECHANICAL PUZZLES

>Mechanical puzzles can be a part of a bigger task or an individual task itself.

Example 1

>Type: safe puzzle with code

>Resources: cardboard, hot glue gun, tape, pen, ruler, circinus/compass/cyrkiel, wooden peg x6.

>Warning: Before attempting to create this puzzle box, fully analyze the tutorial.

>STEP 1:

1. Cut out these shapes from cardboard.

2. Assemble it together with hot glue.

3. The biggest square is the base.

When glueing the pieces together, please consult the graphic at the bottom of the page.

4. Create small holes in the front piece, as shown in the graphic on the right. They should be pieced through completely.

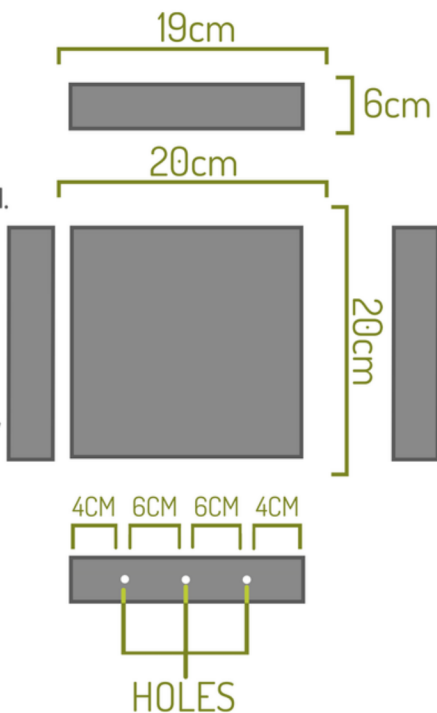

MECHANICAL PUZZLES

>STEP 2:

1. From cardboard, cut out 6 circles. The Radius of the circles should be 2,5 cms.
2. In this step you will be using only 3 of them. Save the other 3 for the next step.
3. Mark each disk with numbers, as shown below. Each disk should look the same.

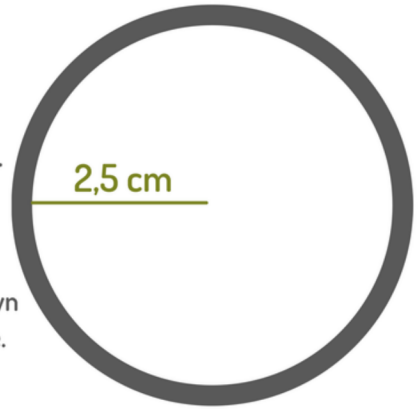

x3
WOODEN
PEG

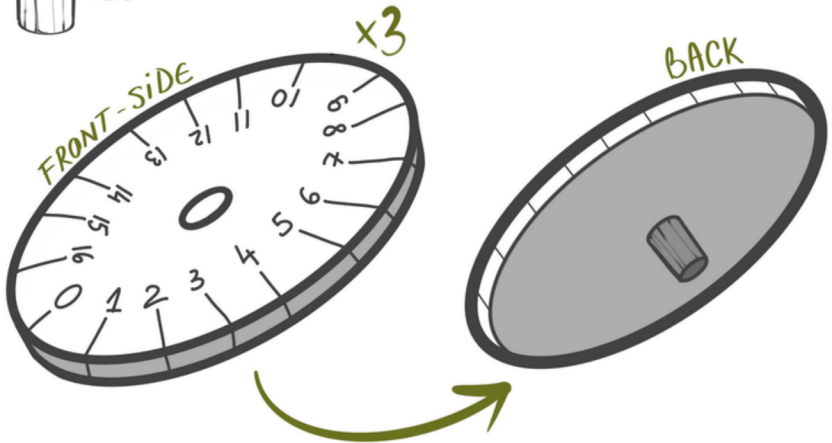

4. Using hot glue, attach the wooden peg to the back of the disc. It should be in the centre! Repeat this with each circle.

MECHANICAL PUZZLES

>STEP 2:

1. Now, we return to the unused disks. To each one of them, you will have to attach a strip of cardboard, using hot glue.



2. The strip should be a little bit shorter than the circumference of the circle in order to create a gap as shown on the right:

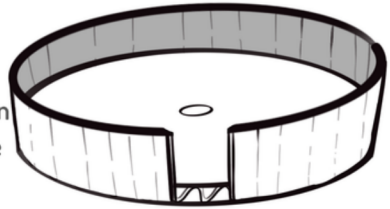

3. The gap should be wide enough to cover one number on the circular dial from step 2.

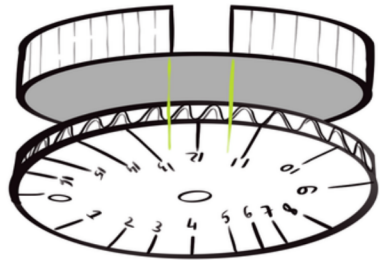

MECHANICAL PUZZLES

>STEP 4:

1. Assemble the disks with the box from step 1.
2. To do that, take disk 1 and put the peg through the holes made in the front piece. (from the outside of the box)
3. Next, from inside of the box attach disk 2. Secure it to the peg with hot glue.
4. Now, you should have a rotating part!

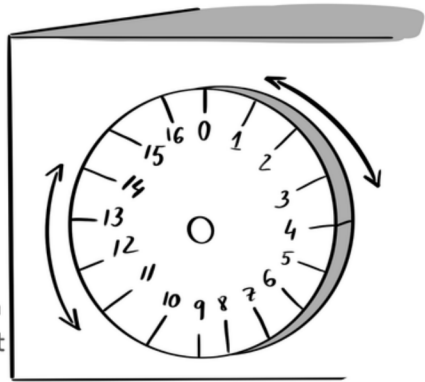

! REMEMBER !

>While assembling the pieces, take note that the gap on disk 2 should be equal to one number from disk 1.

THOSE NUMBERS WILL CREATE A CODE TO OPENING THE SAFE.

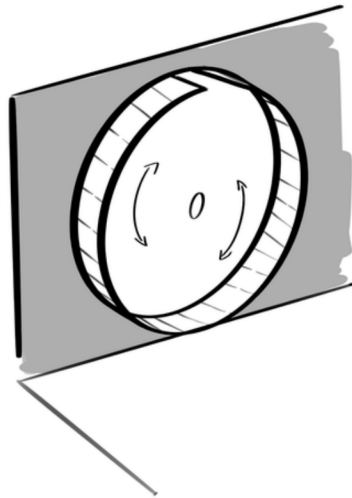

MECHANICAL PUZZLES

>STEP 5:

1. To create the Lid of the box, cut out the cardboard as follows:
 - > one 20 cm x 20 cm square
 - > one 18 cm x 2 cm rectangle
2. Glue the cutouts to each other as shown in the example on the right.

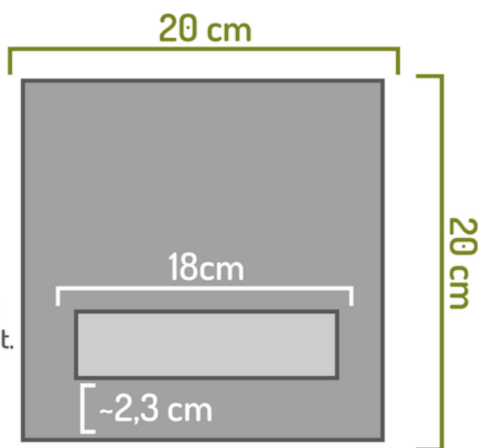

3. Using hot glue, attach 3 wooden pegs to the rectangle as shown in the graphic on the right:

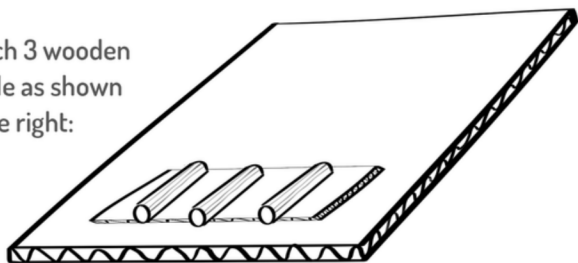

! REMEMBER !

>The wooden pegs should be about 3 cm long. They should stick out of the rectangle when glued down.

MECHANICAL PUZZLES

>STEP 6:

1. Place the lid on top of the box and secure it in place with tape. As shown on the graphic on the right.

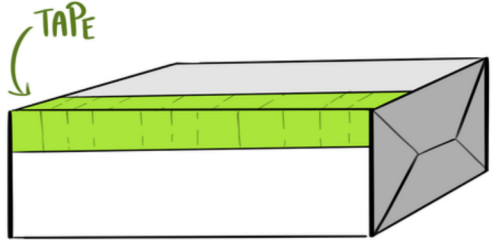

2. Now, the inside of your box should look like the graphic on the right:

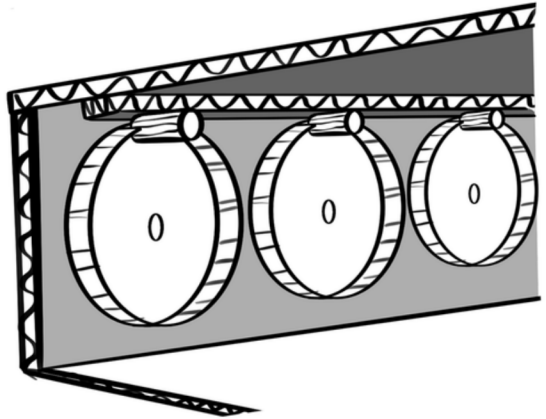

! REMEMBER !

>Remember to write down the code before closing the safe.

DO NOT LOSE THE CODE.

Tip: You can allow the participants to crack the code by themselves or make it part of a bigger game, and place the solution somewhere in the game.

MECHANICAL PUZZLES

Example 2

>Type: ATM puzzle/piggy bank puzzle

>Resources: cardboard, hot glue gun, paper knife, ruler.

>Warning: Before attempting to create this puzzle box, fully analyze the tutorial.

>Step 1

1. From cardboard cut out shapes noted as 1, 2 and 3.

2. Using hot glue, assemble them like in the pictures.

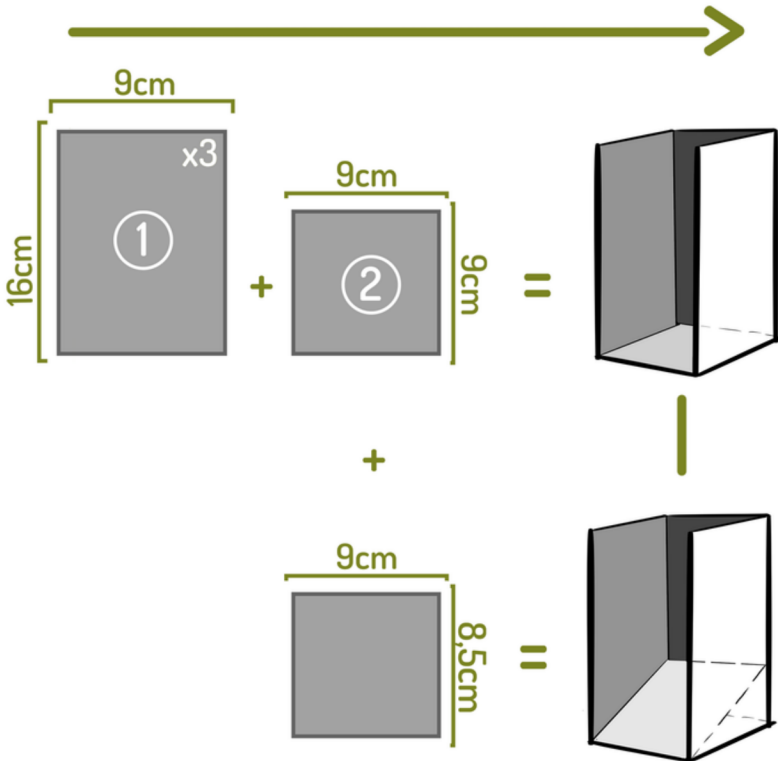

MECHANICAL PUZZLES

>STEP 2:

>From cardboard, cut out the shapes below: 4, 5 and 6. Then, assemble them using hot glue like in the picture below.

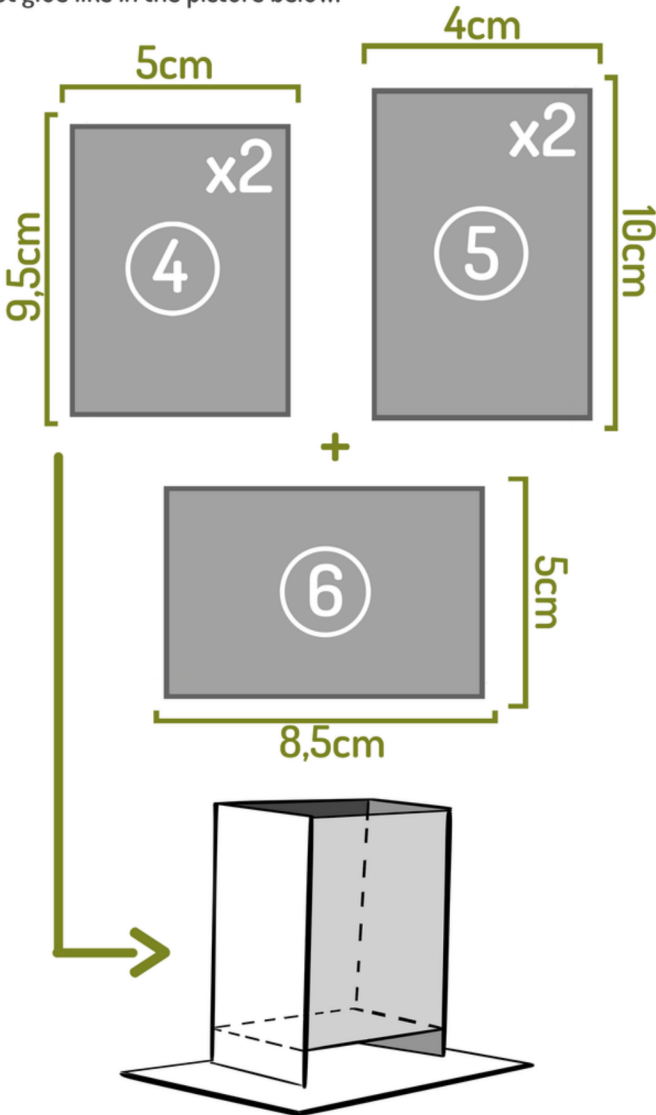

MECHANICAL PUZZLES

>STEP 3:

1. Assemble the parts prepared in step 1 and step 2.
2. From Cardboard, cut out shape 7. On the lower part of shape 7, cut out a rectangular hole, that should be the same width as the inside part (around 4,5cm - 5 cm)
3. Attach the front piece to the box as shown below.

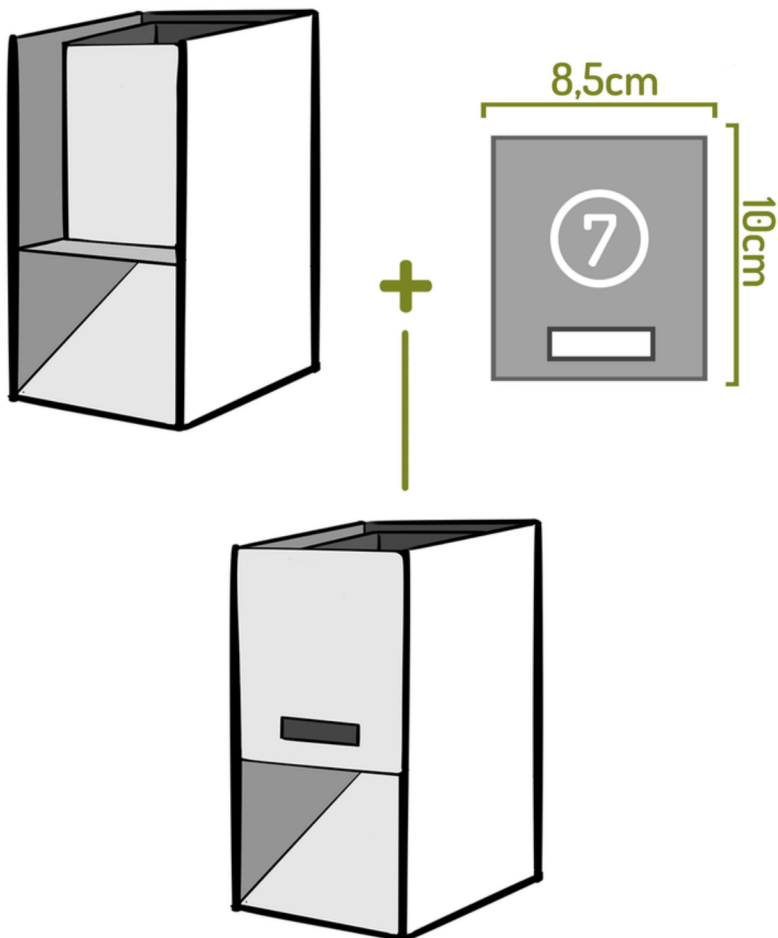

MECHANICAL PUZZLES

>STEP 4:

1. From cardboard, cut out shape 8 and shape 9. Shape 8 will become a lid to the box. In its center, cut a rectangular hole as shown in the graphic. It shouldn't be big, but just wide enough to put stuff through it. Attach shape 8 to the box using hot glue.
2. Shape 9 will become your key card.

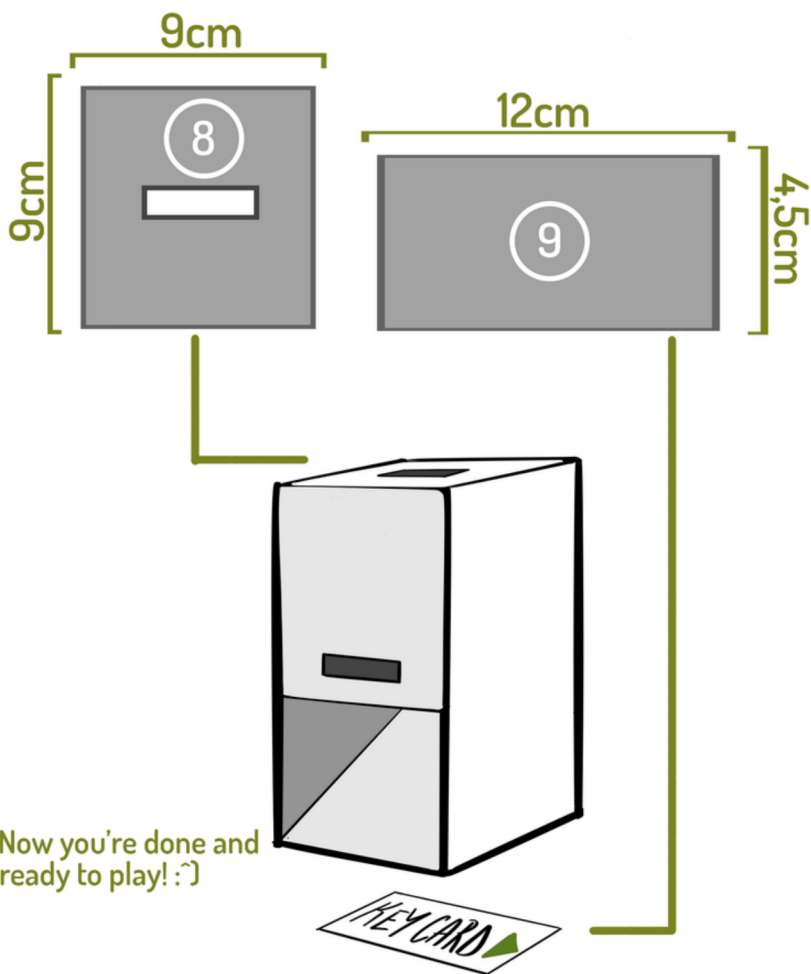



PUZZLES

RANDOM PUZZLE IDEAS

RANDOM PUZZLE IDEAS

Bottle puzzle

>The players find wine bottles. Each bottle has on a label the production year and the type of the wine.

>On the wall they find a wine bottle support with notes with the chronological wine production and the types of wines. The participants must put the bottles in the correct place.

>Transition to other tasks:

-If you have a lock with nine digits, the right places of the bottles might indicate the right buttons to click

-Each place where players can put bottles might have a number above, so after they put all of the bottles, they know the code.

>Variants: You can use any kind of product that fits your room, you can also make your own labels.

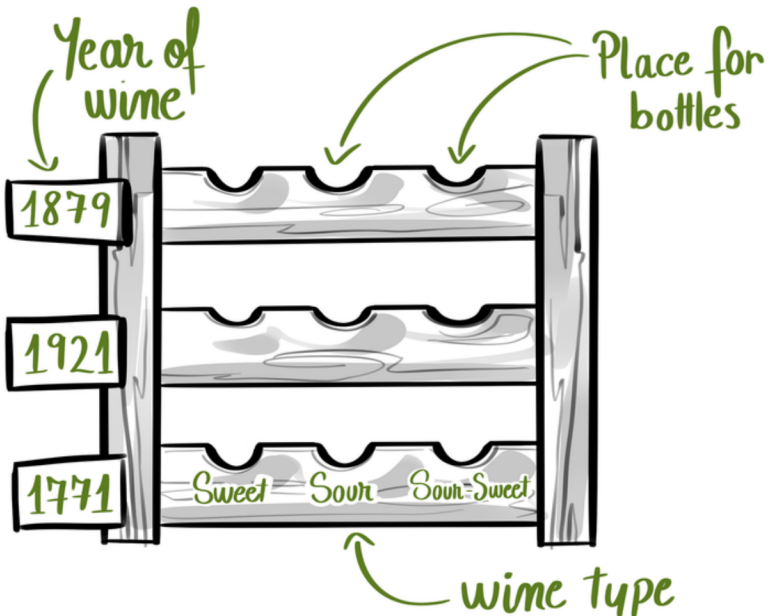

RANDOM PUZZLE IDEAS

Frame puzzle

>On the wall are some wood strips and above them hooks.
>The participants have already found 4 frames and they must arrange them in the hooks. From far away they can observe that the frames and the strips create numbers.

>These numbers represent a code for the next puzzle.

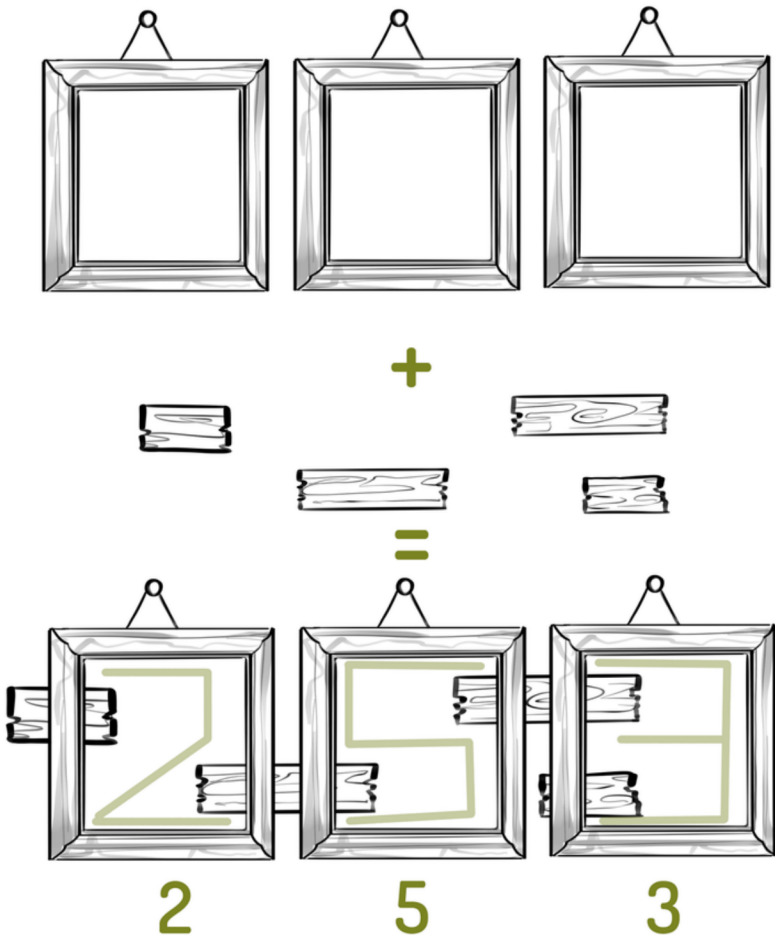

RANDOM PUZZLE IDEAS

Building puzzle

>Players find 8 or 27 cubes, on each cube side there are some unfinished drawings. Players have to put the cubes in the right place in a square, so the pictures are matching.

>Make sure that the inner sides of cubes stay blind and outer is painted!

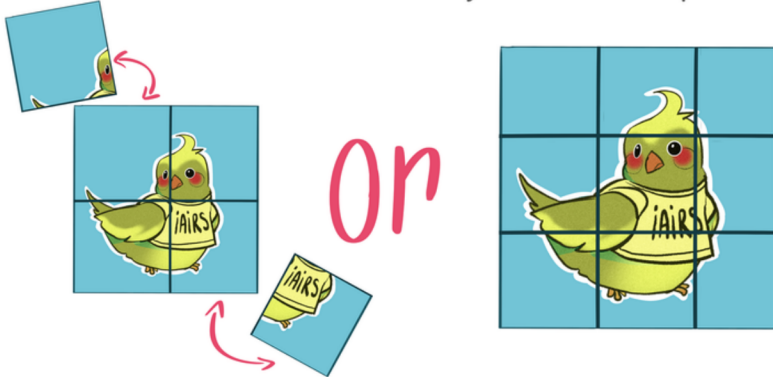

>**Variant:** Instead of making a cube you can make players build a “tower” out of the cubes. In this version you can try organized space, so the place of the tower look like a pillar

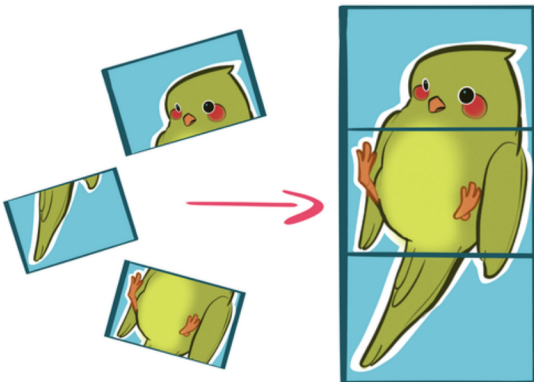

Transition to other puzzles:

-If you can observe your players through monitoring you can slip the next clue trough the doors

-If you use the variant nr.2 you can put some numbers on some boxes, so after they finish building they can see the right code

RANDOM PUZZLE IDEAS

Stamp puzzle

>Players find 4 stamps, ink, and a piece of paper. They should stamp them one on another in correct order. It'll create a number which will be the clue for the next puzzle.

You can make simple stamps using rubber pieces or even a potato.



RANDOM PUZZLE IDEAS

Transparent paper puzzle

>The players find pieces of paper/transparent plastic with different symbols. They must put them one under another and the number will be visible then.

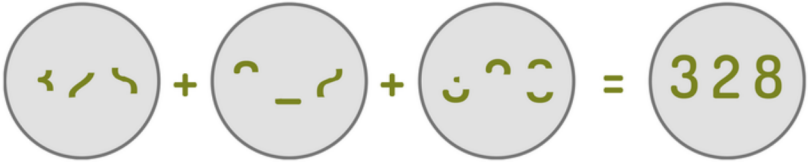

>Variant: You can create a text with missing informations, after finding transparent papers players will have to match the right ones

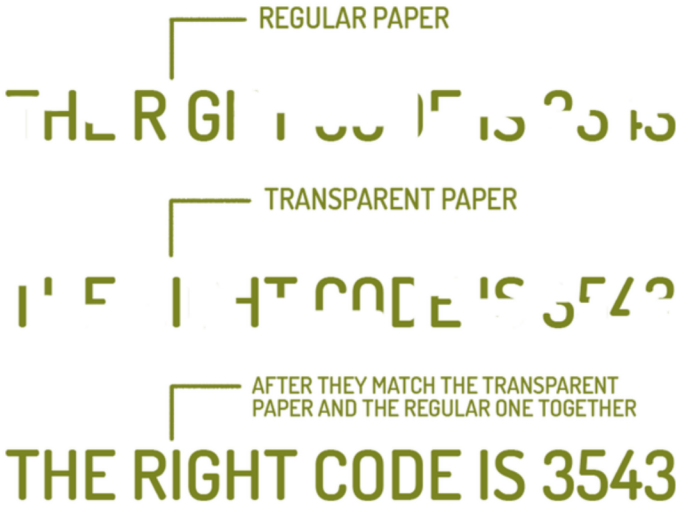

RANDOM PUZZLE IDEAS

Sensory Box puzzle

>Players find the box in the room. The box has only a small entry for an arm, the players have to touch the inside surface of the box in order to sense the code.

>Variants:

- You can use wooden code and attach it to the inner walls to make code convex
- You can put a material on inside walls (like a carpet) the code can be made out of the different material, so the players have to feel the charge of the surface

>Spooky sensory box puzzle

>Usually putting your hand in the unknown is kinda scary, you can use that fact. Putting things like a slime or toy rat might get a little scary element for your players, it's up to your creativity!



RANDOM PUZZLE IDEAS

Tinting Foil puzzle

- >The room has a piece of furniture with glass / plexiglass. Players cannot access the area behind the glass, but there is a clue hidden there.
- >The idea is to put a tinting foil on it, making the inside invisible unless a light source is turned on.
- >The task of the participants is to see the clue behind the glass thanks to the flashlight, which the players acquire through different puzzles.

Counting objects puzzle

- >On the walls and all around the room there are objects that the players need to count. After they know the exact number of objects they can type the right code.
- >So for example In the room there are:



- 6 cats
- 3 polar bears
- 4 pandas

So, the right code would be : 436

GRAPHIC DESIGNER
&
ILLUSTRATOR



SCENARIOS

MADE BY OUR PARTICIPANTS FOR YOU! :~)

MOOD KILLER



Type: Traditional room
Time: Estimated 30 minutes

Story:
On a cruise ship, there are 10 passengers. They are all in the same room, suddenly the lights go out, and after they are back on, there is a dead person on the floor. The dead person is a child trafficker.

Characters: 1 narrator to introduce the story

Participants: Number: 6 persons

Age: 12-20 years old

MATERIALS NEEDED

- >White paint
- >Pieces of paper for evidence signs
- >Ledlight
- >2 panels
- >Colored knots
- >A desk
- >An uv light
- >A piece of paper of a drawing clock
- >A safe
- >An unreadable document
- >Piece of papers for documents
- >Compass
- >An old phone
- >A wall
- >Colored nails
- >Two lock
- >A journal
- >A bed
- >Real wallclocks
- >A mirror

MOOD KILLER

PUZZLE 1

The participants have to look around in the room where the child traficant was killed and find a compass that will be useful for later. They also find a code which they have to solve. The body is marked with white paint on the floor and has a compass near his right hand. The code is on the evidence signs marked around the body.

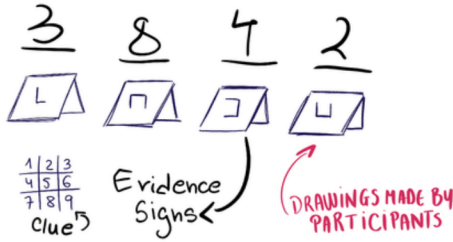

Puzzle 2

When they solve the code, it appears to be a phone number. When they call this number they hear coordinates and with the help of the compass, they get led to a wall with sticked nails in it, and a rope next to it.

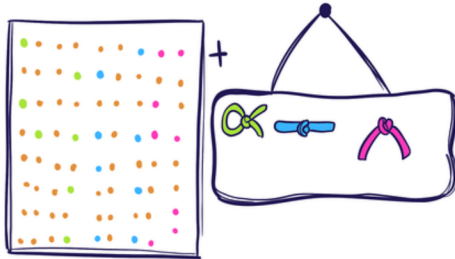

Some of the writings are not finished and the participants have to use UV light, to connect the writing of the capitan. Under the bed of the capitan there is a clickable UV light ball. After they get the UV light and read the journal they find a drawing of a clock. The clock is a clue for the players to look at the clocks on the wall in the main room, where murder was committed.

Puzzle 5

There is a wall full of clocks , but only one of them is not working. The exact time on which the clock has stopped is a code leading to a safe where the personal documents of the participants are kept. They open the safe which is also in the main room and find the documents. One of the documents is unreadable.

Puzzle 6

The players have to find a mirror and put it against the document to read them. Here they will find a real story about a man who was kidnapped as a child by a child traficant. Apparently this man is on the ship and is seeking vengeance. At the end of the story they read the killer name. It So they have solved the escape room.

THE MAGIC PICNIC



Type: Outside escape room
(forest/park)

Time: Estimated 1 h 20 min

Story:

It is a very nice and sunny day! You and the kids are having a picnic. Suddenly, a wizard appears out of nowhere! He tells you that he needs your help: "Friends! Please help me! I need to make a special potion. But my dear friends, the magic animals have the ingredients. You have to help me! We have to go to each animal's home to get the things we need! And we have to be quick! We only have one hour and twenty minutes!"
Will you help the wizard?

Participants: Number: max 5 teams of
4-6 players

Age: 8-12 years old

CHARACTERS

The wizard: This character needs to be with the a team at all times to guide them and help in case of an emergency

The mole: The blind character

The octopus: The deaf character

The snake: This character has a moving disability

The snail: The mute character, is very small and can't talk loud enough

The sloth: This character has a mental disability, they talk very slow and you need to talk to them very slowly in order for them to understand what you are saying

MATERIALS NEEDED

>Picnic basket

>Costumes for the animals and wizard

>Cones (5)

>Smartphone/Mp3

>Containers for the potions (indicatively: bottle, jar, bags)

>Plates/bowls + cutlery

>Ingredients for the potion (indicatively: sugar, cookies, milk, strawberries, cacao, bananas, whipped cream)

>Picnic mat

>Ball with a bell inside

>Headphones

>Blindfolds (bandanas)

>Paper

>Sacks (6, for sack races)

ACTORS

Ideally 6, it can be done with 3 (if the actors rotate and have multiple roles). If you replace the roles with recordings or videos of the characters you will not need any actors. A person (the wizard) needs to be with the children at all times.

THE MAGIC PICNIC

PUZZLE 1

The setting: there are 5 cones one in front of the other. One person, blindfolded, stands behind the first cone and another person stands at the end of the cones. The blindfolded person has a sound ball. The ball has to pass to the end through a zigzag path. The person at the end of the cones, guides the blindfolded. The process is repeated until all the kids become both the blindfolded player and the guide.

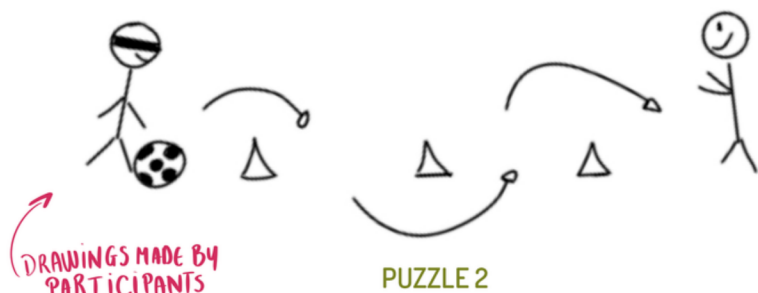

One person (the one who is “underwater”) wears the headphones and listens to ocean audio (<https://youtu.be/s1mZbiXilaQ>) very loudly. Another person stands across from them and tells them the 1st sentence. Then another player wears the headphones and someone else tells them the 2nd sentence. One more time with the 3rd one. The sentences form a riddle, which the kids need to solve in order to reveal the ingredient, in this case sugar.

- 1) White I am like the snow
- 2) They take me out of a cane
- 3) I am sweet, my cousin is honey

PUZZLE 3

- a. You make pairs. One of you will have to “walk” with their arms as shown in the picture, and find the 1st ingredient
- b. You make groups of 3 people, one of you will have to sit on the others arms like the 2nd picture.
- c. Each one of you gets a sack, you will have to get inside and move around by jumping. Find the last ingredient.



THE MAGIC PICNIC

PUZZLE 4

The kids play charades, one person takes the paper with a word and tries to describe it using only gestures to his team. After the team guesses the word correctly, another person takes new paper. Words that you can use:

- Monkey
- Snake
- Spiderman
- The Little Mermaid
- Basketball

PUZZLE 5

Participants have to solve a cipher, you can use any cipher mentioned in our Toolkit.

Make sure to prepare an answer key, something that will help kids solve the cipher without ruining the fun.

>Through our game, we wanted to familiarize children with various disabilities and increase their awareness of this subject.

>After playing the game, we would suggest having a meeting with a youth worker that works with people with fewer opportunities. Which brings closer the problems faced by children and helped not perpetuate stereotypes that may arise while playing our game

CIRCUS: BEHIND THE SCENES



Type: Traditional room
Time: Estimated 30 minutes

Story:
A group of children are excited to go to a circus with their school, but they are shocked by the way the animals are treated so they decide that they have to save them. They will have to work together to end animal abuse and set them free.

Characters: no characters
Participants: Number: 4-6 people
Age: 10-14 years old

MATERIALS NEEDED

- >Stickers for making the shirts
- >Christmas lights
- >4 stuffed animals
- >Cardboard for making the cages and the sliding
- >Puzzle (optionally cages can be replaced by boxes)
- >MP3 and earphones or a speaker
- >1 plastic sheet
- >Pen and paper for the riddles
- >Locks and padlocks

CIRCUS: BEHIND THE SCENES

PUZZLE 1

Put a sticker on each of the participants, one on the chest and another one on the back, so that they decipher a code that allows them to open the door. The chest sticker will be a shape and the back one will be a number.



Puzzle 2

For the first cage they need to solve a simple sliding puzzle, which can be created by taking cardboard box and making a small maze out of it. We put key on one part of the end and the other one we make a small hole for the key to be taken out. Once they get the key they can unlock the cage. Inside the cage there is a lion toy.

You can make any maze mentioned in our toolkit, or generate one from this website:

<https://www.mazegenerator.net/>,

Puzzle 3

Participants will have a colorful map drawn in a transparent plastic and a sheet with different points drawn as well as 3 numbers for each color. Putting them one over the other gets you the right color and the pin to the lock, unlocking the second cage. Inside the cage there is an elephant toy.

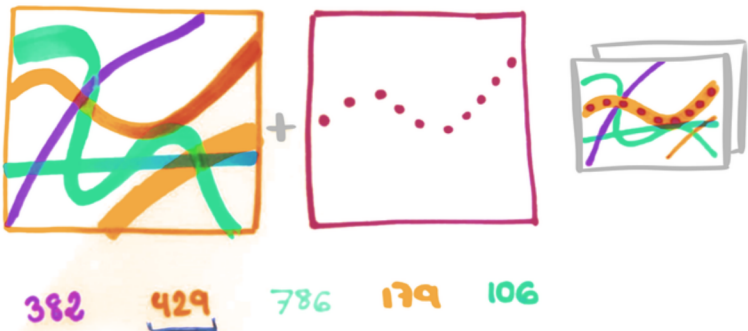

CIRCUS: BEHIND THE SCENES

PUZZLE 4

In each cage unlocked there was a piece of paper with different lines. When you connect the three pieces, 3 numbers appear, which are the code for this lock. Inside the box there is also an mp3 player as well as headphones. Inside the cage there is a bear toy.



PUZZLE 5

The mp3 and the headphones from the previous cage have different animal sounds on them and the participants need to put the animal toys in the same order as the sounds. When they do it an outside person opens the door and they have escaped.



DRAWINGS MADE BY PARTICIPANTS

SEVEN WONDERS ROBBERY



Type: Hybrid (traditional + virtual)
Time: Estimated 45 minutes

Story:
Some aliens arrived on earth and stole some of the most precious monuments, the seven wonders of ancient age. In this quest you will help return them to their rightful place.

Characters: no characters
Participants: Number: no limit
Age: 12+

MATERIALS NEEDED

- >paper sheets with the riddles
- >2 boxes with combination lock
- >Colourful paints
- >Printed picture from the zeus statue
- >Paper with the origami shapes
- >Marker to write the numbers
- >Tape
- >Decoration paper and tape to cover the toilet paper
- >Book
- >Toilet rolls
- >laptop
- >Scissors
- >Magnifier
- >4 frames
- >Projector

SEVEN WONDERS ROBBERY

PUZZLE 1

There is a notification on the screen of the players, which is the title of a book in the room, and a random number that stands for a specific page of the book. The players have to search for the book and open it to this page. There they will find a paper with a 4 digits password, that opens the padlock of a box in the room. In there they will find pieces of paper with some letters on each one.

1st paper: F I R L N Z
2nd paper: O A P S Z N

The players are provided with a paper. On it are written some words, but with some missing letters. (TEM_ _ _ _ _ TEM_ _ _).

Participants have to remove the common letters from the pieces they found in the box and place the correct ones to the incomplete sentence.

Correct answer: **TEMPLE OF ARTEMIS**

Need: 4 paper sheets, book, box with the lock

PUZZLE 2

Participants take a spire with directions to follow on a chessboard full of letters from ancient Egypt. The directions guide them to form the word "PYRAMID"

The board has letters on the left side and numbers on the top side and the spire provides guides to form the correct word by moving from a box to another (eg. A-4, B-1 etc).

Need: 2 paper sheets, 1 paper sheet somewhere in the room with translation of the Egyptian alphabet.

Variants: If you can have a real chessboard and players that know how to play chess. You can use any variant of moves you want, so for example if the bishop is the one that should move to a certain square, the pon has to move first making the room for bioshop to pass.

PUZZLE 3

Participants are gonna find certain paper rolls with uncompleted symbols and letters on the sides of them. They have to put the one on top of the other in the right way so that they form the correct word.

Need: toilet rolls, colorful paints, duct tape, decoration paper for the toilet paper

SEVEN WONDERS ROBBERY

PUZZLE 4

A picture of the zeus statue is hanging somewhere in the room, and there are 4 missing pieces on it. The players are provided with the 3 of them after solving the 3 previous puzzles. The last one is hidden in a locked box. In order to open this box they need a 3 digits password that is formed by the numbers written on the back of the previous 3 missing pieces.

Need: printed pictures from zeus state, digital locker, scissors

PUZZLE 5

Some shapes are given to the players, which they have to use to form the animal in the picture they are watching on the screen. After the animal is formed, the teacher validates by giving them a UV flashlight. Now they have to use it to find the hidden letters on the back of each piece and form the word "Colossus of Rhodes". Notification on the screen: type password.

Need: paper with origami shapes, scissors, UV flashlight, marker, UV marker

PUZZLE 6

A maze appears on the screen with random numbers on each route.

Notification message: find the correct route on the maze. Then an empty box appears and there is another notification: type the correct numbers.

The teacher has to validate the correct answer by explaining that these numbers stand for the coordinates of the wonder (Lighthouse of Alexandria)

You can use any maze mentioned in our toolkit or create digital one using this website: <https://www.mazegenerator.net/>

PUZZLE 7

Screen notification: The wall is telling you the required code. Participants need to find the frames around the classroom and place them on the wall to read the code. The teacher has to place some pieces of duct tape on the wall, in a way that a 4 digits code is formed after the frames are hung on the wall. The players have to use the code to unlock the next screen and discover the last wonder.

Need: 4 frames, duct tape

